



**PRODUCT
CATALOGUE**
2023



ABOUT US

At FAKRO, we are committed to creating beautiful spaces with natural light. Discover the transformational effects of natural light on your home and well-being with FAKRO roof windows, light tunnels, and accessories.

Our products are manufactured from sustainably sourced, high-quality natural pine, UPVC, and aluminum, and are designed with safety, performance, and the customer in mind. With over 30 years experience globally and over 20 years in the UK, we understand our customers and your aspirations. We are here to help you achieve those dreams, support you through every step and create beautiful spaces with natural light.

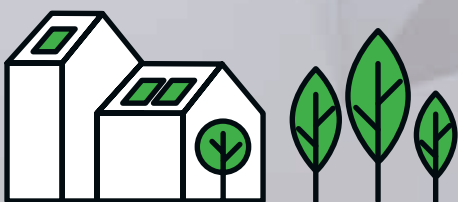

CONTENTS

GO GREEN	5
WHY CHOOSE FAKRO	6
HOW TO CHOOSE A ROOF WINDOW	8
HOW TO CHOOSE A FLASHING KIT	9
CENTRE PIVOT ROOF WINDOWS	10-11
Z-WAVE (ELECTRIC) & SOLAR CENTRE PIVOT ROOF WINDOWS	12-13
WIFI CENTRE PIVOT ROOF WINDOWS	14-15
HIGHLY ENERGY EFFICIENT PIVOT ROOF WINDOWS	16-17
TOP HUNG AND CENTRE PIVOT ROOF WINDOWS preSelect MAX	18-19
HIGH PIVOT ROOF WINDOWS AND DUET ROOF WINDOWS	20-21
BALCONY WINDOWS - GALERIA	22-23
L-SHAPED VERTICAL COMBINATION WINDOWS	24-25
SMOKE VENTILATION WINDOWS	26-27
SIDE-HUNG ESCAPE WINDOWS	28-29
ROOF ACCESS WINDOWS	30-31
FLASHINGS FOR ROOF WINDOWS	32-33
ROOF WINDOW ACCESSORIES	34-36
ACCESSORIES FOR OPENING WINDOWS, INSTALLATION ACCESSORIES	37
FLAT ROOF WINDOW STRUCTURE	38
SAFETY & FUNCTIONALITY	39
FLAT ROOF WINDOWS TYPE F	40-51
FLAT ROOF WINDOWS TYPE G	42-43
FLAT ROOF WINDOWS TYPE Z	44
WALK ON FLAT ROOF WINDOWS	45
FLAT ROOF WINDOWS TYPE C	46-47
SMOKE VENTILATION FLAT ROOF WINDOWS	48
FLAT ROOF ACCESS	49
FLAT ROOF ACCESS DOOR	50
ACCESSORIES	51
LIGHT TUNNELS	52
FLAT ROOF LIGHT TUNNELS	53
ROOF WINDOW PERFORMANCE AT A GLANCE	54-55
FLAT ROOF WINDOW PERFORMANCE AT A GLANCE	56-57
OTHER PRODUCTS	58
WINDOW SIZE GUIDE	59





GO GREEN

We are committed to embedding sustainability and environmental responsibility into everything we do.

As a global market player, we understand the impact we make on the environment and strive to make a difference, from investing in sustainable production processes to developing eco-friendly products.

In 2022, we launched our GO GREEN initiative which underpins everything we do. As part of the initiative, we have implemented an environmental management system, in doing so, we are able to improve our environmental performance through more efficient use of resources and reduction of waste.

The UN Sustainability Development Goals are the blueprint to achieve a better and more sustainable future for all. To ensure we build a better future for generations to come, FAKRO is contributing to the achievement of such Goals.



WHY CHOOSE FAKRO?

Our windows offer a perfect combination of style, sustainability, security and long design life. To achieve such high performance involves ongoing product development and improvement to every roof window that we design.

EXCEPTIONAL SECURITY

FAKRO's topSafe system gives confidence and peace of mind that our roof windows offer exceptional burglary resistance with additional reinforcement to prevent the sash from being forced open.

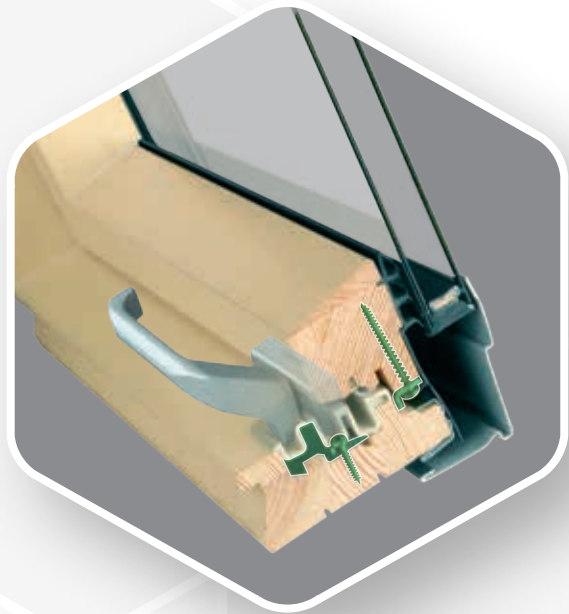

10-YEAR WARRANTY

Whether buying natural pine, UPVC or any other style, FAKRO offers a 10-year warranty for all roof windows. We also offer a no-quibble lifetime warranty against damage by hailstones.

10 year
warranty
for window

20 year
warranty
for glazing unit

∞ Lifetime
glazing unit hail
resistance warranty

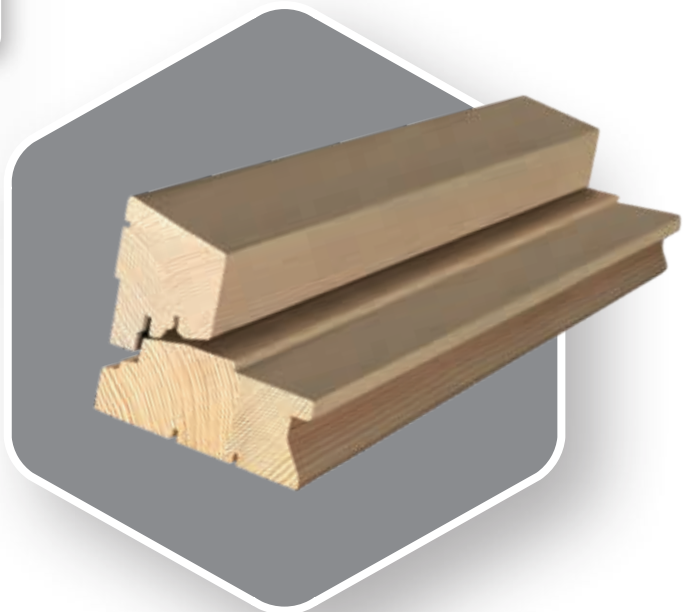

TOP QUALITY MATERIAL

The pine we use offers the clearest visual evidence of our roof window quality. Not only does its close grain look stylish, we obtain timber from FSC® certified sources.

CUSTOMER SUPPORT

We are on-hand via phone on 01283 554 755 or via livechat on our website. Our dedicated, friendly customer service and technical support teams will happily guide you through your project needs.



DEDICATED TO SUSTAINBLE LIVING

From high energy-saving glazing, to recyclability to responsibly sourced pine, sustainability is in our DNA. We ensure that every process, every action and every decision we make is always accompanied by concern for the comfort and well-being of future generations.



DON'T JUST TAKE OUR WORD FOR IT...

"I ordered a pitched roof window. Loved how it brightened up the room. So much so, that we ordered a second one. Excellent customer service when I phoned up to repeat my order."

- MT, Homeowner

CERTIFICATES





HOW TO CHOOSE A ROOF WINDOW

1 FIND OUT YOUR ROOF PITCH



? **DID YOU KNOW?**
The glass area should be at least 15-20% of the total floor area for maximum results.

It is important to understand what pitch your roof is. This will determine which window and flashing kit is most appropriate for your project. If you're not sure what your roof pitch is, we would suggest contacting your builder.

2 CHOOSE YOUR STYLE



Depending on your roof pitch, you may decide a pitched roof window or a flat roof window is the best option. For a pitched roof, you may want our best-selling centre pivot roof window and as for a flat roof, the domed option might be a preference.

3 CHOOSE YOUR FINISH



We offer 4 standard internal finishes; these are Natural Pine, White Acrylic, White Polyurethane and White UPVC. Natural Pine and White Acrylic are our most popular but if you are installing the window into a kitchen or bathroom, the White Polyurethane and White UPVC are designed to withstand high humidity.

4 DO YOU LIVE IN A CONSERVATION AREA?



We offer conservation windows that are suitable for properties in a conservation area. If you are unsure, and your builder and/or architect isn't sure either, your local planning authority will advise.

5 MANUAL OR ELECTRIC?



Electric roof windows are perfect for those hard to reach places – equipped with a rain sensor that automatically closes as soon as it begins to rain.

6 CHOOSE YOUR GLAZING

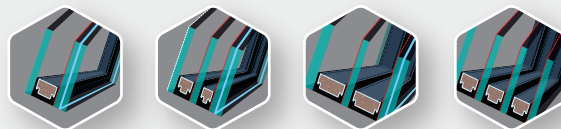

There are numerous glazing types available for FAKRO roof windows. They are as follows:
P2 - Double glazed, toughened outer pane
P5 - Triple glazed, anti-burglary
U6 - Triple glazed, high energy-efficient
U8 - Quadruple glazed, Passivhaus certified

HOW TO CHOOSE A FLASHING KIT













Depths explained

N - High profiled flashing kit (+3cm)

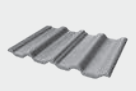

V - Standard depth flashing kit

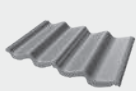
J - Recessed flashing kit (-3cm)





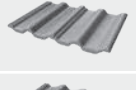
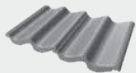

STANDARD FLASHING

Type of roofing material	Roof pitch	Fitting depth	Flashing	
 <p>Roof coverings such as: - roofing felt - bitumen - flat sheet metal</p>	+ 15° – 90°	V(0)	= ES	
	+ 20° – 90°	J (-3 cm)		
 <p>Roof coverings such as: - bitumen - slate</p>	+ 20° – 90°	V(0)	= EL	
		J (-3 cm)		
 <p>Plain Tile roof coverings non-interlocking (Peg Tiles)</p>	+ 25° – 90°	V(0)	= EP	
		J (-3 cm)		
 <p>Profiled roof coverings such as: - roof tiles - corrugated metal sheeting</p>	+ 15° – 90°	N (+3 cm)	= EZ	
	+ 15° – 90°	V(0)		
	+ 20° – 90°	J (-3 cm)		
 <p>High profile roof coverings such as: - roof tiles - corrugated metal sheets</p>	+ 15° – 90°	N (+3 cm)	= EH	

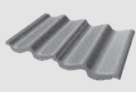
LOW PITCH FLASHINGS

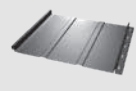
Type of roofing material	Roof pitch	Flashing	
 <p>Roof coverings such as: - roofing felt - bitumen - corrugated metal sheeting</p>	+ 10° – 75°	= E_A	
	 <p>Profiled roof coverings such as: - roof tiles - corrugated metal sheeting</p>		
 <p>High profile roof coverings such as: - roof tiles - corrugated metal sheeting</p>			

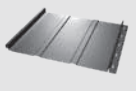
OTHER FLASHINGS

Type of roofing material	Roof pitch	Fitting depth	Flashing	
 <p>High profile roof coverings such as: - roof tiles - corrugated metal sheeting</p>	+ 15° – 90°	V(0)	= EH_-AT Thermo	
	+ 15° – 90°	N (+3 cm)		
 <p>Roof coverings such as: - flat sheet metal - standing seam zinc etc</p>	+ 15° – 90°	V(0)	= EE	
	+ 20° – 90°	J (-3 cm)		
 <p>Roof coverings such as: - steel panel sheet with prefabricated (system) joints</p>	+ 15° – 90°	V(0)	= EB	
	+ 20° – 90°	J (-3 cm)		



BEST SELLER

CENTRE PIVOT ROOF WINDOWS



● Our most popular range of windows with a wide range of accessories



● Easy cleaning as the centre pivot sash rotates 180 degrees



● Increased safety due to the topSafe system



● Handle at the bottom for easy operation



● 10-year warranty on all roof windows

GLAZING EXPLAINED



P2 - Double glazed, toughened outer pane



P5 - Triple glazed, anti-burglary

INTERNAL FINISHES

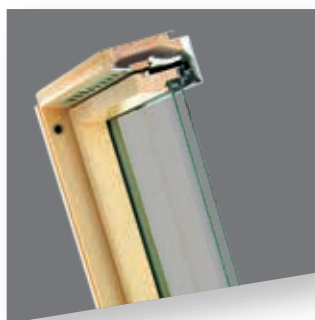

FTP-V

NAUTRAL PINE

- Automatic air ventilation V40P
- Knot-free high quality pine wood
- Double coated wood with eco-friendly lacquer



FTW-V

WHITE ACRYLIC

- Automatic air ventilation V40P
- Knot-free high quality pine wood
- Double coated wood with white eco-friendly lacquer



FTU-V

WHITE POLYURETHANE

- Automatic air ventilation V40P
- Knot-free high quality pine wood
- Designed for humid rooms such as bathrooms and kitchens



PTP-V

UPVC

- Highly efficient air inlet V35
- Reinforced steel core for high-performance
- Ideal for high-humidity rooms such as bathrooms, kitchens and utilities

SIZES AVAILABLE

windows external dimensions [cm]	55x78	55x98	55x118	66x98	66x118	78x98	78x118	78x140	78x160	94x118	94x140	114x118	114x140	134x98	94x160
effective glazing area [m ²]	0.21	0.29	0.37	0.38	0.47	0.47	0.59	0.72	0.82	0.75	0.92	0.95	1.16	0.92	0.75
size symbol	01	02	16	03	04	05	06	07	13	08	09	10	11	12	80
DOUBLE GLAZED	✓	✓	✓	✓	✓	✓	✓	✓	✓	✓	✓	✓	✓	✓	✓
TRIPLE GLAZED	✓	✓	✓	✓	✓	✓	✓	✓	✓*	✓	✓	✓*	✓*	✓*	✓*

*UPVCTRIPLE GLAZED VERSION NOT AVAILABLE



CONSERVATION STYLE AVAILABLE



ALSO AVAILABLE IN ELECTRIC (Z-WAVE).
Turn to page 12 and 13



FOR BLINDS AND ACCESSORIES SEE PAGE:
See p ages 34 - 37



Z-WAVE (ELECTRIC) & SOLAR CENTRE PIVOT ROOF WINDOWS



● Our most popular range of windows with a wide range of accessories



● Open and close your windows at the touch of a button. Z-Wave windows also come with a rain sensor as standard so they shut automatically at the first drop of rain



● No need to wire into the mains with our Solar roof windows. Fitted with a solar panel on the outside of the window to generate the power to open



● Easy cleaning as the centre pivot sash rotates 180 degrees



● Increased safety due to the topSafe system



● 10-year warranty on all roof windows

GLAZING EXPLAINED



P2 - Double glazed, toughened outer pane



P5 - Triple glazed, anti-burglary



INTERNAL FINISHES



FTP-V Z-Wave & Solar

NAUTRAL PINE

- Automatic air ventilation V40P
- Knot-free high quality pine wood
- Double coated wood with eco-friendly lacquer



FTW-V Z-Wave & Solar

WHITE ACRYLIC

- Automatic air ventilation V40P
- Knot-free high quality pine wood
- Double coated wood with white eco-friendly lacquer



FTU-V Z-Wave & Solar

WHITE POLYURETHANE

- Automatic air ventilation V40P
- Knot-free high quality pine wood
- Designed for humid rooms such as bathrooms and kitchens



ZRW7 - wireless wall switch to control up to 12 devices



ZRH12 - remote to control up to 12 devices



ZWL1 - hard wired switch controlling 1 device (2 and 3 are available)



ZWMA4 - adaption module to connect to home automation systems, Alexa and Google Home

SIZES AVAILABLE

windows external dimensions [cm]	55x78	55x98	55x118	66x98	66x118	78x98	78x118	78x140	78x160	94x118	94x140	114x118	114x140	134x98	94x160
effective glazing area [m ²]	0.21	0.29	0.37	0.38	0.47	0.47	0.59	0.72	0.82	0.75	0.92	0.95	1.16	0.92	0.75
size symbol	01	02	16	03	04	05	06	07	13	08	09	10	11	12	80
DOUBLE GLAZED	✓	✓	✓	✓	✓	✓	✓	✓	✓	✓	✓	✓	✓	✓	✓
TRIPLE GLAZED	✓	✓	✓	✓	✓	✓	✓	✓	-	✓	-	-	-	✓	-



CONSERVATION STYLE AVAILABLE



ALSO AVAILABLE IN WIFI.
See page 14 and 15



FOR BLINDS AND ACCESSORIES SEE PAGE:
See pages 34 - 37



WIFI CENTRE PIVOT ROOF WINDOWS



● Easily connects to home automation systems, for example, Alexa and Google Home



● Can be controlled via smart phones with a compatible app



● Easy cleaning as the centre pivot sash rotates 180 degrees



● Increased safety due to the topSafe system



● 10-year warranty on all roof windows

GLAZING EXPLAINED



P2 - Double glazed, toughened outer pane



P5 - Triple glazed, anti-burglary



INTERNAL FINISHES

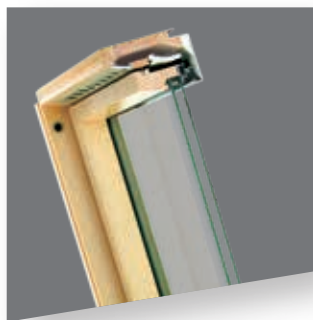

FTP-V^{WiFi}

NAUTRAL PINE

- Automatic air ventilation V40P
- Knot-free high quality pine wood
- Double coated wood with eco-friendly lacquer



FTW-V^{WiFi}

WHITE ACRYLIC

- Automatic air ventilation V40P
- Knot-free high quality pine wood
- Double coated wood with white eco-friendly lacquer



FTU-V^{WiFi}

WHITE POLYURETHANE

- Automatic air ventilation V40P
- Knot-free high quality pine wood
- Designed for humid rooms such as bathrooms and kitchens

WiFi CONTROL ELEMENTS



REMOTE WiFi - remote to control 3 devices in 4 groups



ZFC - Control unit to transform electro centre pivot to WiFi system

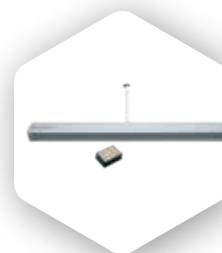

ZFZ 230 ZRD - Update kit for easy transforming manual window to WiFi system.

SIZES AVAILABLE

windows external dimensions [cm]	55x78	55x98	55x118	66x98	66x118	78x98	78x118	78x140	78x160	94x118	94x140	114x118	114x140	134x98	94x160
effective glazing area [m ²]	0.21	0.29	0.37	0.38	0.47	0.47	0.59	0.72	0.82	0.75	0.92	0.95	1.16	0.92	0.75
size symbol	01	02	16	03	04	05	06	07	13	08	09	10	11	12	80
ALL	✓	✓	✓	✓	✓	✓	✓	✓	✓	✓	✓	✓	✓	✓	✓



CONSERVATION STYLE AVAILABLE



FOR BLINDS AND ACCESSORIES SEE PAGE:
See pages 34 - 37



**SAVE MONEY
ON UTILITY BILLS**

HIGHLY ENERGY EFFICIENT PIVOT ROOF WINDOWS



- Specialist triple and quadruple glazing to keep your home warmer and save you money on utility bills



- Easy cleaning as the centre pivot sash rotates 180 degrees



- Increased safety due to the topSafe system



- Handle at the bottom for easy operation



- 10-year warranty on all roof windows

GLAZING EXPLAINED



U6 - Triple glazed, energy-efficient



U8 - Quadruple glazed, highly energy-efficient

INTERNAL FINISHES

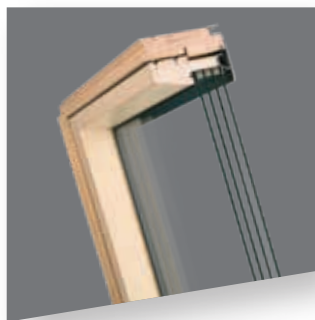

FTT

NAUTRAL PINE

- Knot-free high quality pine wood
- Double coated wood with eco-friendly lacquer

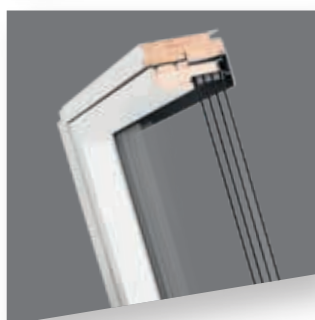

FTT/W

WHITE ACRYLIC

- Knot-free high quality pine wood
- Double coated wood with white eco-friendly lacquer

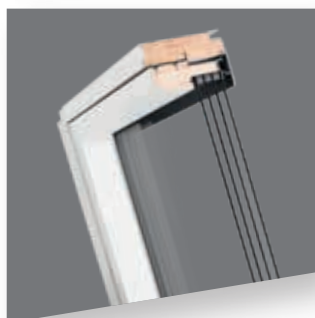

FTT/U

WHITE POLYURETHANE

- Knot-free high quality pine wood
- Designed for humid rooms such as bathrooms and kitchens



Windows FTT U8 Thermo designed for passive house buildings, Passive House certified

SIZES AVAILABLE

windows external dimensions [cm]	55x98	55x118	66x98	66x118	78x98	78x118	78x140	78x160	94x118	94x140	114x118	114x140	134x98	94x160
effective glazing area [m ²]	0.29	0.37	0.38	0.47	0.47	0.59	0.72	0.82	0.75	0.92	0.95	1.16	0.92	0.75
size symbol	02	16	03	04	05	06	07	13	08	09	10	11	12	80
TRIPLE GLAZED	✓	✓	✓	✓	✓	✓	✓	✓	✓	✓	✓	✓	✓	✓
QUADRUPLE GLAZED	✓	✓	✓	✓	✓	✓	✓	-	✓	-	-	-	✓	-



CONSERVATION STYLE AVAILABLE



FOR BLINDS AND ACCESSORIES SEE PAGE:
See pages 34 - 37



TOP HUNG AND CENTRE PIVOT ROOF WINDOWS preSelect MAX



- Dual function roof window can be opened in top hung mode or centre pivot giving you greater spread of natural light but also easy cleaning



- preSelect MAX can be opened in any position from 0-45



- Increased safety due to the topSafe system



- Handle at the bottom for easy operation - remove two-step micro opening



- 10-year warranty on all roof windows

GLAZING EXPLAINED



P2 - Double glazed, toughened outer pane



P5 - Triple glazed, anti-burglary



INTERNAL FINISHES

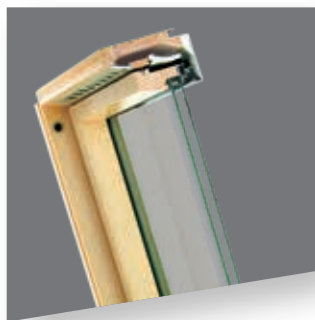

FPP-V preSelect MAX

NAUTRAL PINE

- Automatic air ventilation V40P
- Knot-free high quality pine wood
- Double coated wood with eco-friendly lacquer



FPW-V preSelect MAX

WHITE ACRYLIC

- Automatic air ventilation V40P
- Knot-free high quality pine wood
- Double coated wood with white eco-friendly lacquer



FPU-V preSelect MAX

WHITE POLYURTHANE

- Automatic air ventilation V40P
- Knot-free high quality pine wood
- Designed for humid rooms such as bathrooms and kitchens

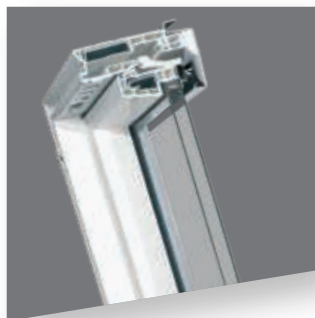

PPP-V preSelect MAX

UPVC

- Highly efficient air inlet V35
- Reinforced steel core for high-performance
- Ideal for high-humidity rooms such as bathrooms, kitchens and utilities

SIZES AVAILABLE

windows external dimensions [cm]	55x98	55x118	66x98	66x118	78x98	78x118	78x140	78x160	94x118	94x140	114x118	114x140	134x98	94x160
effective glazing area [m ²]	0.29	0.37	0.38	0.47	0.47	0.59	0.72	0.82	0.75	0.92	0.95	1.16	0.92	0.75
size symbol	02	16	03	04	05	06	07	13	08	09	10	11	12	80
UPVC	✓	✓	✓	✓	✓	✓	✓	✓	✓	✓	✓	✓	-	-
ALL OTHER	✓	✓	✓	✓	✓	✓	✓	✓	✓	✓	✓	✓	✓	✓

NOTE- Golden oak, pine, or anthracite veneer available on request. Please contact your FAKRO representative for further information.



CONSERVATION STYLE AVAILABLE



FOR BLINDS AND ACCESSORIES SEE PAGE:
See pages 34 - 37



**LARGE AND
FUNCTIONAL**

HIGH PIVOT ROOF WINDOWS AND DUET ROOF WINDOWS



● High pivot roof windows give greater headroom within the space



● With a larger window and glazing area, the Duet style provides more daylight into the room



● Easy cleaning as the centre pivot sash rotates 160 degrees



● Increased safety due to the topSafe system



● Handle at the bottom for easy operation - remove two-step micro opening



● 10-year warranty on all roof windows

GLAZING EXPLAINED



P2 - Double glazed, toughened outer pane



P5 - Triple glazed, anti-burglary



INTERNAL FINISHES



FYP-V proSky

FDY-V Duet proSky

NAUTRAL PINE

- Automatic air ventilation V40P
- Knot-free high quality pine wood
- Double coated wood with eco-friendly lacquer



FYW-V proSky

WHITE ACRYLIC

- Automatic air ventilation V40P
- Knot-free high quality pine wood
- Double coated wood with white eco-friendly lacquer



FYU-V proSky

FDY-V/U Duet proSky

WHITE POLYURETHANE

- Automatic air ventilation V40P
- Knot-free high quality pine wood
- Designed for humid rooms such as bathrooms and kitchens

SIZES AVAILABLE

windows external dimensions [cm]	78x160	78x180	78x206	94x160	94x180	94x206
effective glazing area [m ²]	0.85	0.92	1.19	1.07	1.22	1.46
size symbol	13	40	42	80	41	43
DOUBLED GLAZED	✓	✓	✓	✓	✓	✓
TRIPLE GLAZED	✓	✓	✓	-	✓	-

SIZES AVAILABLE - DUET STYLE

windows external dimensions [cm]	78x206	78x235	94x206	94x235
size symbol	CB	CC	DB	DC
DOUBLED GLAZED	✓	✓	✓	✓



CONSERVATION STYLE AVAILABLE



FOR BLINDS AND ACCESSORIES SEE PAGE:
See pages 34 - 37



BIGGER SPACE

BALCONY WINDOWS - GALERIA



- Get the effect of a balcony at the fraction of the cost!



- An innovative, large roof window with two opening sashes - creating more space and a balcony-effect



- Easy cleaning as the centre pivot sash rotates 180 degrees



- Increased safety due to the topSafe system



- 10-year warranty on all roof windows

GLAZING EXPLAINED



- P2 - Double glazed**, toughened outer pane



- P5 - Triple glazed**, anti-burglary



INTERNAL FINISHES

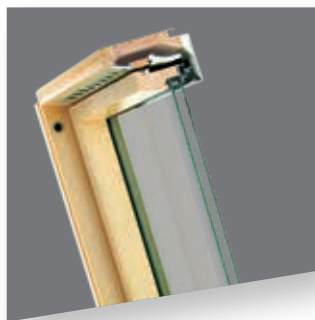

FGH-V Galeria

NAUTRAL PINE

- Automatic air ventilation V40P
- Knot-free high quality pine wood
- Double coated wood with eco-friendly lacquer



FGH-V/W Galeria

WHITE ACRYLIC

- Automatic air ventilation V40P
- Knot-free high quality pine wood
- Double coated wood with white eco-friendly lacquer



FGH-V/U Galeria

WHITE POLYURETHANE

- Automatic air ventilation V40P
- Knot-free high quality pine wood
- Designed for humid rooms such as bathrooms and kitchens

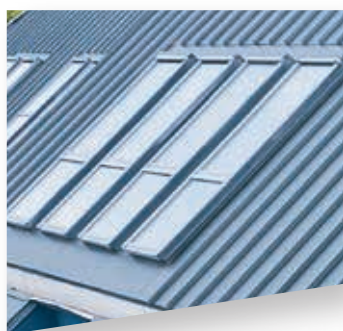

- Barriers when closed are concealed under the window flashing elements , so they do not collect dirt or spoil aesthetics of the roof.
- Made to order
Balcony window available only with installation performed by authorised service.
- Combining FGH-V balcony window with other FAKRO windows, e.g. FDY-V is possible with a combination flashing - price on request

SIZES AVAILABLE

windows external dimensions [cm]	78x255	94x255	114x255	windows external dimensions [cm]	78x255	94x255	114x255
effective glazing area [m ²]	1,32	1,67		ELV/G	✓	✓	✓
DOUBLED GLAZED	✓	✓	✓	EZV-A/G	✓	✓	✓
TRIPLE GLAZED	✓	✓	-	EHN-A/G	✓	✓	✓
				EHN-AT Thermo/G	✓	✓	✓









SPECIAL ORDER BLINDS AVAILABLE.
GET IN TOUCH FOR MORE INFORMATION.





ENHANCED
FIELD OF VIEW

L-SHAPED VERTICAL COMBINATION WINDOWS

-  ● L-shaped windows are designed to be installed where the roof meets a vertical wall
-  ● Vastly increases the amount of light entering the room
-  ● Vertical window and pitched roof window are ordered separately
-  ● Increased safety due to the topSafe system

-  ● As standard they are equipped with multi-point lock fittings and with P2 or P5 safety glazing
-  ● 10-year warranty on all roof windows

GLAZING EXPLAINED

-  **P2 - Double glazed**, toughened outer pane
-  **P5 - Triple glazed**, anti-burglary



INTERNAL FINISHES



BD_, BVP, BXP

NAUTRAL PINE

- Knot-free high quality pine wood
- Double coated wood with eco-friendly lacquer

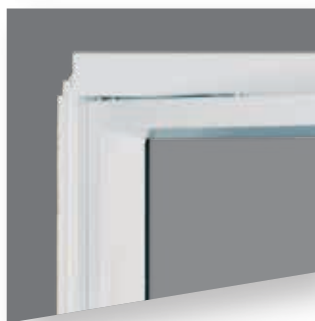

BD_/W, BVW, BXW

WHITE ACRYLIC

- Knot-free high quality pine wood
- Double coated wood with white eco-friendly lacquer

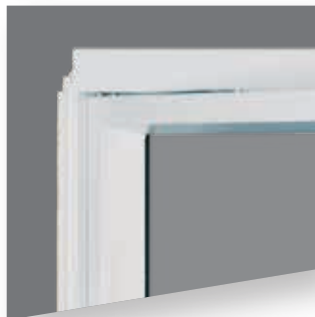

BD_/U, BVU, BXU

WHITE POLYURETHANE

- Knot-free high quality pine wood
- Designed for humid rooms such as bathrooms and kitchens

OPENING



TILT & TURN



TILT



NON-OPENING

SIZES AVAILABLE

windows external dimensions [cm]	78x60	78x75	78x95	78x115	78x137	94x75	94x95	114x75	114x95
effective glazing area [m ²]	0.25	0.33	0.45	0.57	0.71	0.42	0.58	0.53	0.73
size symbol	33	81	82	83	84	85	86	89	90
TILT & TURN	✓	✓	✓	✓	✓	✓	✓	-	✓
TILT	✓	✓	✓	✓	✓	✓	✓	✓	✓
NON-OPENING	✓	✓	✓	✓	✓	✓	✓	✓	✓



CONSERVATION STYLE AVAILABLE



FOR BLINDS AND ACCESSORIES SEE PAGE:
See pages 34 - 37



**EVACUATE
HEAT AND SMOKE**

SMOKE VENTILATION WINDOWS



- Intended to evacuate heat and smoke from inside the building during fire



- Factory equipped with an electric actuator (24V) which when connected to the control system opens and closes the window



- Fitted with a chain actuator to open the sash to 90 degrees in relation to the frame



- 5-year warranty



- Meets UK building regs and are fully tested and certified to EN 12101-2:2003



- All kits are supplied for onsite installation and commissioning by others

GLAZING EXPLAINED



P2 - Double glazed, toughened outer pane



P5 - Triple glazed, anti-burglary

INTERNAL FINISHES

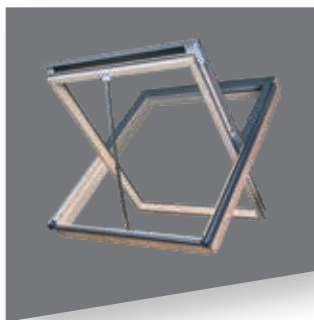

FSR

NAUTRAL PINE

- Knot-free high quality pine wood
- Double coated wood with eco-friendly lacquer

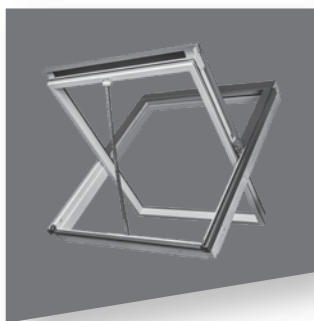

FSR/W

WHITE ACRYLIC

- Knot-free high quality pine wood
- Double coated wood with white eco-friendly lacquer

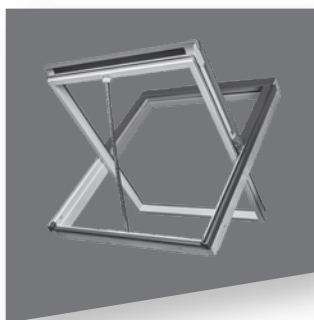

FSR/U

WHITE POLYURETHANE

- Knot-free high quality pine wood
- Designed for humid rooms such as bathrooms and kitchens



COMES SUPPLIED AS A KIT:

ALL ELECTRICS AND FLASHINGS INCLUDED

Please advise flashing kit type required at time of order

SIZES AVAILABLE

windows external dimensions [cm]	78x140	114x98	114x118	134x118
effective glazing area [m ²]	0.72	0.76	0.95	1.15
size symbol	07		10	18
DOUBLED GLAZED	✓	✓	✓	✓
TRIPLE GLAZED	✓	✓	✓	✓



CONSERVATION STYLE AVAILABLE



SIDE-HUNG ESCAPE WINDOWS



- The FWP escape window is side-hung and therefore side-opening. Once unlocked, the sash can be opened to 90°



- The gas piston fitted in the top part of the window facilitates opening and stabilizes the sash



- Universal design allows installation with any opening side (right or left)



- Handle positioned in the middle of the sash allows opening and microopening



- 10-year warranty on all roof windows

GLAZING EXPLAINED



- **P2 - Double glazed**, toughened outer pane



- **P5 - Triple glazed**, anti-burglary



INTERNAL FINISHES

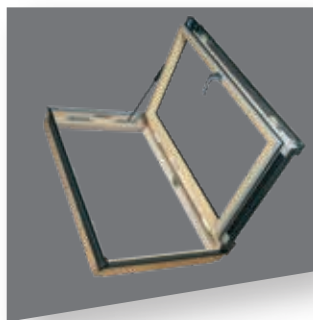

FWP

NAUTRAL PINE

- Knot-free high quality pine wood
- Double coated wood with eco-friendly lacquer

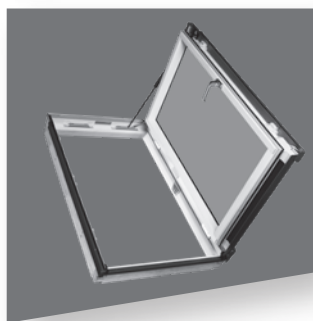

FWW

WHITE ACRYLIC

- Knot-free high quality pine wood
- Double coated wood with white eco-friendly lacquer

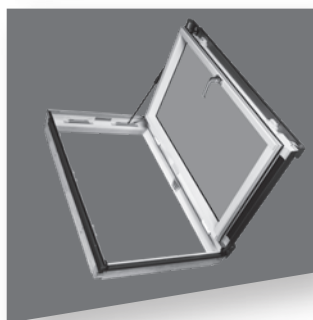

FWU

WHITE POLYURETHANE

- Knot-free high quality pine wood
- Designed for humid rooms such as bathrooms and kitchens

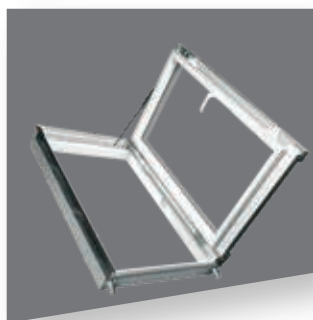

PWP

UPVC

- Reinforced steel core for high-performance
- Ideal for high-humidity rooms such as wet room and laundry rooms

SIZES AVAILABLE

windows external dimensions [cm]	55x98	66x78	66x98	66x118	78x98	78x118	94x98
effective glazing area [m ²]	0.29	0.28	0.38	0.47	0.47	0.59	
size symbol	02	22	03	04	05	06	08
DOUBLE GLAZED	✓	✓	✓	✓	✓	✓	✓
TRIPLE GLAZED	✓	✓	✓	✓	✓	✓	✓



CONSERVATION STYLE AVAILABLE



SPECIAL ORDER BLINDS AVAILABLE.
GET IN TOUCH FOR MORE INFORMATION.



ROOF ACCESS WINDOWS

- Roof access windows provide fast, safe and easy access to the roof for conservation and required maintenance work. Depending on the room type in the loft (inhabited or uninhabited) a range of access windows can be used.
- Designed solely for uninhabited lofts with the interior temperature similar to the outdoor temperature.
- Roof access windows come with an integrated flashing compatible with most type roofs.

GLAZING EXPLAINED

- Single glazed unit

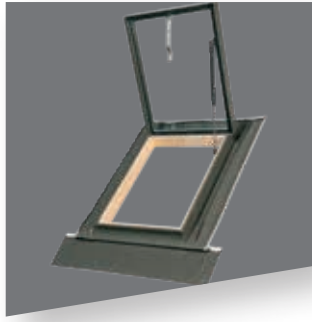

WG_

- Access roof light has a top hung design and the sash opens outwards
- WGT with single toughened glass 4H,
- WGI with glazing unit 4H-9-4H and gas spring,

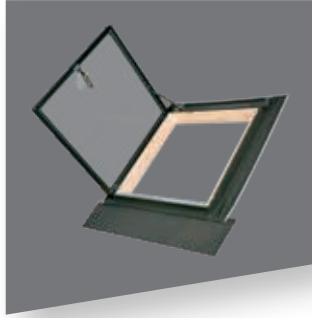

WLI

- Access roof light opens to the side, equipped with glazing 4H-8-4H
- It can be installed in left or right opening version
- It comes complete with a turn limiter to hold the sash stable

SIZES AVAILABLE

window dimensions [cm]	46x55	46x75
WGT	✓	✓
WGI	✓	✓
window dimensions [cm]	54x83	86x87
WLI	✓	✓

**particularly suited to tile roofs*



FLASHINGS FOR ROOF WINDOWS

- Flashings are essential for a tight connection of roof windows with roofing material
- They ensure a durable, weatherproof and tidy fit with good drainage away from the window
- Variety of standard roof window flashings, as well as a number of specialist sets including angle-changing, recessed, combination and conservation



Standard flashings allow window to be installed in the most popular types of roofing materials:

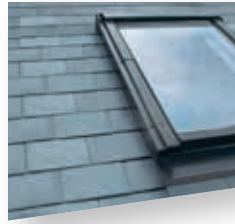

EL_

for flat roof coverings
bitumen/slate plain tiles
up to 10mm thick



ES_

for flat roof coverings
up to 10mm thickness



EP_

for plain tiles up to
16mm thick



EZ

for profiled roof
coverings up to 45mm
depth



EH_

for deeply profiled
roof coverings up to
90mm depth



EBV-V

for panel metal
sheeting such as
standing seam

If unsure, please speak to the team on 01283 554755.

SIZES AVAILABLE

windows dimensions [cm]	55x78	55x98	55x118	66x98	66x118	78x98	78x118	78x140	78x160	94x118	94x140	114x118	114x140	134x98	94x160
size symbol	01	02	16	03	04	05	06	07	13	08	09	10	11	12	80

ALL

✓ ✓ ✓ ✓ ✓ ✓ ✓ ✓ ✓ ✓ ✓ ✓ ✓ ✓ ✓ ✓

CONSERVATION STYLE AVAILABLE

THERMO FLASHINGS ALSO AVAILABLE

COMBINATION FLASHINGS

The combination flashing are ready made flashing systems for joining windows in groups: horizontally, vertically and in a block. The distance between windows joined horizontally and vertically is normally 10cm.

There are seven modules in the FAKRO combination system, to cater for any layout you may require.

Other gutter channels are available.



B2/1

Horizontal combination



B1/2

Vertical combination



B2/2

Block combination

SIZES AVAILABLE

windows dimensions [cm]	55x78	55x98	55x118	66x98	66x118	78x98	78x118	78x140	78x160	94x118	94x140	114x118	114x140	134x98	94x160
size symbol	01	02	16	03	04	05	06	07	13	08	09	10	11	12	80

ALL

✓ ✓ ✓ ✓ ✓ ✓ ✓ ✓ ✓ ✓ ✓ ✓ ✓ ✓ ✓ ✓

CONSERVATION STYLE AVAILABLE



**PROTECTIVE
AGAINST HEAT LOSS**

ROOF WINDOW ACCESSORIES

- FAKRO roof window accessories combine functional and operational features with attractive designs
- Interior accessories can put the finishing touches on any roof window. The wide range of blind type, style and colour ensures complete harmony with your chosen decor and helps shape a room's character
- Exterior accessories (awning and blind) effectively protect against excessive heating of the attic on hot summer days
- Accurate adjustment of accessories to FAKRO roof windows ensures their quick and easy assembly. The original FAKRO accessories are characterised by high quality, innovative solutions and aesthetic appearance

EXTERNAL ACCESSORIES

NEW LINE



Awning blinds **AMZ**

- Offers up to 8 times more effective protection in comparison with internal blackout blinds
- Effective shading of the room at the same time providing a view to the outside
- The best protection from tiresome heat

Control:

- **AMZ** manually operated or with the use of a control rod (supplied with blind)
- **AMZ Z-Wave** system, controlled by remote control or wall switch
- **AMZ Solar** controlled by remote control



External roller shutters **ARZ**

- Effective protection from tiresome heat
- Colour matches the window - RAL 7022
- Shading of the room
- Increased security
- Increases the feeling of privacy
- Acoustic protection against external noise
- Not suitable for UPVC roof windows

Control:

- **ARZ-H** operated manually from the inside with a crank (supplied in package)
- **ARZ Z-Wave** system, controlled by remote control or wall switch
- **ARZ Solar** controlled by remote control, recommended in places where there is no 230V power supply

SIZES AVAILABLE - AWNING BLINDS

windows dimensions [cm] size symbol	55x78 01	55x98 02	55x118 16	66x98 03	66x118 04	78x98 05	78x118 06	78x140 07	78x160 13	94x118 08	94x140 09	114x118 10	114x140 11	134x98 12	94x160 80
MANUAL	✓	✓	✓	✓	✓	✓	✓	✓	✓	✓	✓	✓	✓	✓	✓
Z-WAVE (ELECTRIC)	✓	✓	✓	✓	✓	✓	✓	✓	✓	✓	✓	✓	✓	✓	✓
SOLAR	✓	✓	✓	✓	✓	✓	✓	✓	✓	✓	✓	✓	✓	✓	✓

SIZES AVAILABLE - EXTERNAL SHUTTERS

windows dimensions [cm] size symbol	55x78 01	55x98 02	55x118 16	66x98 03	66x118 04	78x98 05	78x118 06	78x140 07	78x160 13	94x118 08	94x140 09	114x118 10	114x140 11	134x98 12	94x160 80
MANUAL	✓	✓	✓	✓	✓	✓	✓	✓	✓	✓	✓	✓	✓	✓	✓
Z-WAVE (ELECTRIC)	✓	✓	✓	✓	✓	✓	✓	✓	✓	✓	✓	✓	✓	✓	✓
SOLAR	✓	✓	✓	✓	✓	✓	✓	✓	✓	✓	✓	✓	✓	✓	✓

INTERNAL ACCESSORIES



venetian blinds **AJP**

- Reduction of incoming light to the room
- Control the direction and the amount of the light entering by changing the angle of the slats providing a view to the outside



dimming roller blind **ARP**

- Protection against sunlight during sunny days
- Possibility to lock the blind in any position



blackout blinds **ARF**

- Very good protection from sunlight
- Possibility to lock the blind in any position
- Partial protection from solar heat



pleated blinds **APS**

- Provide a soft and diffused light into the room
- Possibility to lock the blind in any position
- Top-down system easy operation by top and bottom bar

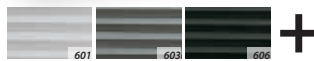
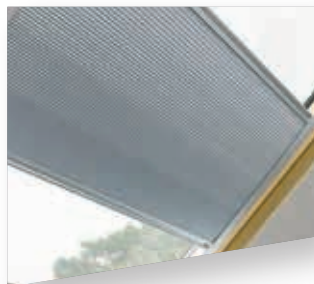

pleated blinds **APF**

- Gradual reduction of the incoming sunlight up to the black out
- Possibility to lock the blind in any position
- Top-down system - easy operation by using the upper and lower beams



insect screen **AMS**

- Protection against insects
- Minimum shading of the room
- Can be installed with other internal and external accessories



FULL RANGE OF COLORS MATERIALS AVAILABLE ON:
<https://www.fakro.co.uk/products/all-products/accessories-for-roof-windows/>

SIZES AVAILABLE

windows dimensions [cm]	55x78	55x98	55x118	66x98	66x118	78x98	78x118	78x140	78x160	94x118	94x140	114x118	114x140	134x98	94x160
size symbol	01	02	16	03	04	05	06	07	13	08	09	10	11	12	80

ALL

✓	✓	✓	✓	✓	✓	✓	✓	✓	✓	✓	✓	✓	✓	✓	✓
---	---	---	---	---	---	---	---	---	---	---	---	---	---	---	---

* ARP NOT AVAILABLE IN SIZE 78x160

AMS commercial size	55x170	55x200	66x200	66x240	78x200	78x240	94x200	94x240	114x200	114x240	134x200	134x240
lining opening width [cm]	49.5	49.5	60.5	60.5	72.5	72.5	88.5	88.5	108.5	108.5	128.5	128.5
lining opening maximum height [cm]	170	200	200	240	200	240	200	240	200	240	200	240

INSECT SCREEN

✓	✓	✓	✓	✓	✓	✓	✓	✓	✓	✓	✓	✓
---	---	---	---	---	---	---	---	---	---	---	---	---

ACCESSORIES FOR OPENING WINDOWS



Telescopic pole **ZST**

- Enables the operation of windows and blinds that are beyond the users reach. It can reach up to 2.7m but an extension pole (ZSP) is available



Window restrictor **ZBB**

- Window restrictor -enabling safe sash opening in the tilt position up to 10cm



Window lock **ZBL**

- Aesthetic window lock ZBL in white, prevents accidental opening of the window, is mounted at the bottom of the window

INSTALLATION ACCESSORIES

FAKRO installation accessories guarantee quick and easy connection between the roof window and the roof construction. Using original installation accessories will allow the proper use of windows for many years.



XLC Internal lining

- Ensures proper finish around the window from the inside of the room. The XLC -F for wooden windows, XLC -P for aluminum-plastic windows. The bottom part of lining perpendicular and the upper one parallel to the floor, ensures adequate lighting and proper air circulation over the surface of the glass

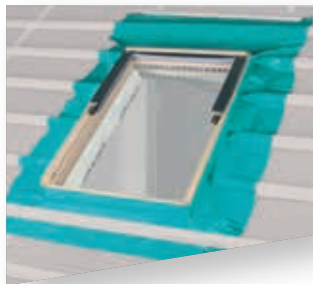

XDP Insulating set

- Designed to enable fast, tight air-permeable and thermal insulation around the window to be installed
- The set consists of air-permeable membrane and thermo-insulating material made of natural wool in shape of wool cubes and wool tress.
- XDP insulation set together with XDS air-tight collar form a XDK insulation package



XDS Air-tight flashing

- Is secured internally to form air-tight barrier around the window against warm and humid air as any moisture on the surface of the insulation greatly reduces its thermal insulation properties

SIZES AVAILABLE

windows dimensions [cm]	55x78	55x98	55x118	66x98	66x118	78x98	78x118	78x140	78x160	94x118	94x140	114x118	114x140	134x98	94x160
size symbol	01	02	16	03	04	05	06	07	13	08	09	10	11	12	80
ALL	✓	✓	✓	✓	✓	✓	✓	✓	✓	✓	✓	✓	✓	✓	✓

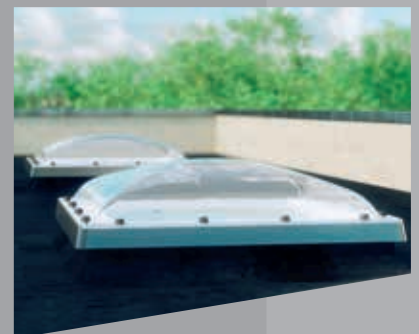
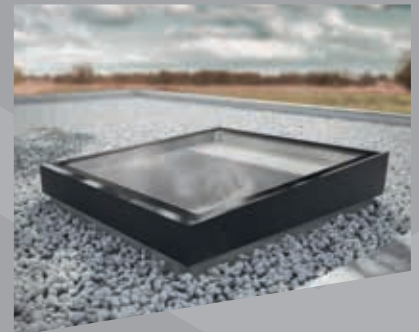

FLAT ROOF WINDOW STRUCTURE

A flat roof window frame is constructed using reinforced multi-chamber PVC profiles. The internal surface of the frame is white (RAL 9010). The material used in the profile features high resistance against acids and has low moisture absorption. As a result, the window can be installed in every room.

Profiles are filled with insulation material, thus additionally improving the energy saving parameters of the product. The specially profiled covering material under the frame drip cap further improves the ultimate finish between the window and the roof covering.



The servo-motor in electrically opened windows is positioned in the sash and is protected against adverse weather conditions such as rain and snow.

This ensures trouble free operation of the servo-motor and all control elements.

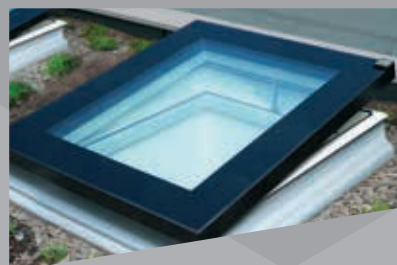

The electrically operated windows (type C, type F, type G and type Z) have a built-in sensor that automatically activates the sash closing function when it rains.

Electric actuator situated in the window sash allows for sash maximum micro-opening up to 150mm.

SAFETY & FUNCTIONALITY



HIGH SAFETY

Flat roof windows DMF DU6 Secure, DXF DU6 Secure, DMC P4 Secure and DXC P4 Secure comply with European anti-burglary class RC2 (EN 1627). They are also characterised by the highest impact resistance (Class SB 1200 - EN 1873).

Installation of such windows in flat roofs increases operational safety and anti-burglary resistance of buildings.



AMPLE NATURAL LIGHT

The basic function of the window is to provide an abundance of natural light in buildings with flat roofs. With specially designed shapes of the sash and frame profiles, flat roof windows feature up to 16% greater

glazing area when compared with other manufacturer's windows of a similar size. With such solution interiors under a flat roof are full of daylight.



NON-STANDARD SIZES

In addition to standard sizes, type F windows can be manufactured in non-standard dimensions (in the range of 60x60cm - 120x220cm). Thermal insulation standards of buildings have been significantly increased and old skylights in flat roofs will not meet current requirements. The specification of a type F

window enables existing, often non-standard skylights to be replaced with ease. Taking advantage of such opportunity provides high flexibility when designing or renovating buildings.



ACCESSORIES AND CONTROL

Installing the right internal and external accessories enhances functionality and aesthetic appearance of windows in the roof. Use of an external awning blind protects the room from overheating, while internal

accessories provide protection from intense sunlight and enhance interior design.



SLEEK AND MODERN DESIGN

FLAT ROOF WINDOWS TYPE F



- The D_F non-domed flat roof window is characterised by exceptional thermal insulation qualities and innovative design



- Suitable for roof pitches between 2 and 15 degrees



- Can be mounted on an additional base with a height of 15cm.



- Solar version available - powered by solar energy through the included PV panel and built-in battery.



- Secure version available



- Accessories available

GLAZING EXPLAINED



DU6 - Triple glazed, energy-efficient



DU8 - Quadruple glazed, highly energy-efficient

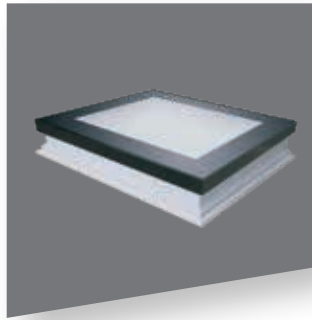

DXF

- Non-opening.

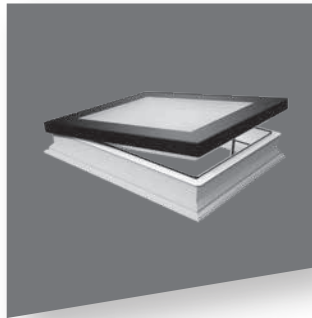

DMF

- Opened manually by means of ZSD control rod 2.2m long included
- Sash tilts 30cm

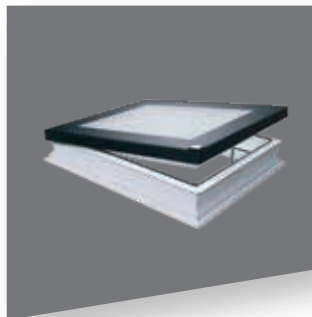

DEF

- Electrically opened with wireless Z-Wave system.
- Included in the kit: AC adaptor, rain sensor
- Sash tilts 15cm

SOLAR VERSION AVAILABLE

POPULAR ACCESSORIES

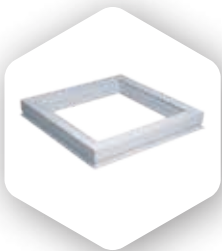

XRD

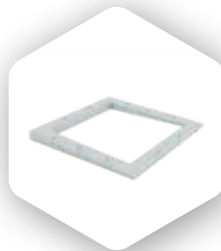

XRD/A

SIZES AVAILABLE

windows external dimensions [cm]	60x60	60x90	70x70	80x80	90x60	90x90	90x120	100x100	100x150	120x90	120x120	120x220	140x140	150x100	200x100
effective glazing area [m ²]	0,23	0,37	0,33	0,46	0,37	0,6	0,83	0,77	1,21	0,83	1,16	2,23	1,63	1,21	1,64
size symbol	01K	02K	03K	04K	31K	05K	06K	07K	10K	32K	08K	11K	09K	33K	34K
TRIPLE GLAZED	✓	✓	✓	✓	✓	✓	✓	✓	✓	✓	✓	✓	✓	✓	✓
QUADRUPLE GLAZED	✓	✓	✓	✓	✓	✓	✓	✓	✓	✓	✓	✓	✓	✓	✓



SPECIAL ORDER BLINDS AVAILABLE.
GET IN TOUCH FOR MORE INFORMATION.

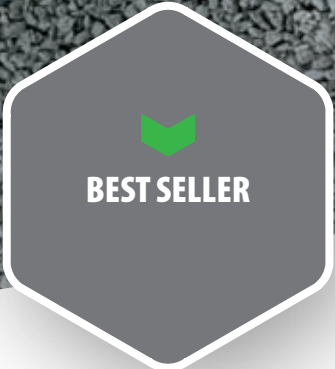

FLAT ROOF WINDOWS TYPE G



- Our best selling range of technologically advanced flat roof windows



- Can be mounted on an additional base with a height of 15cm



- Most sizes are suitable for roof pitches between 2 and 15 degrees - sizes from 140x140 to 120x220cm require the roof pitch to be between 5-15 degrees



- Internal accessories available

GLAZING EXPLAINED



- **P2 - Double glazed**, toughened outer pane

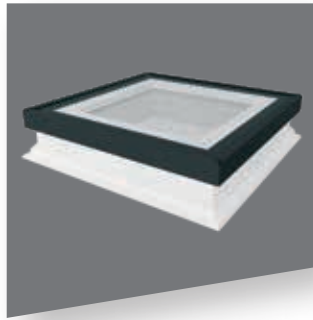

DXG

- Non-opening.

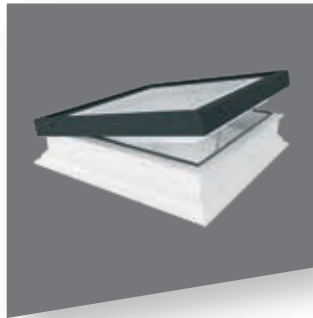

DMG

- Opened manually by means of ZSD control rod 2.2m long included
- Sash tilts 30cm

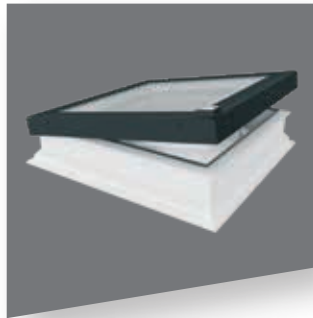

DEG

- Electrically opened with wireless Z-Wave system.
- Included in the kit: AC adaptor, rain sensor
- Sash tilts 15cm

SOLAR VERSION AVAILABLE

POPULAR ACCESSORIES

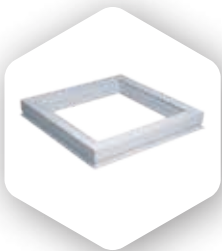

XRD

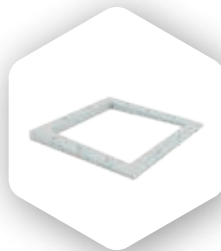

XRD/A

SIZES AVAILABLE

windows external dimensions [cm]	60x60	60x90	70x70	80x80	90x60	90x90	90x120	100x100	100x150	120x90	120x120	120x220	140x140	150x100	200x100
effective glazing area [m ²]	0,23	0,37	0,33	0,46	0,37	0,6	0,83	0,77	1,21	0,83	1,16	2,23	1,63	1,21	1,64
size symbol	01K	02K	03K	04K	31K	05K	06K	07K	10K	32K	08K	11K	09K	33K	34K
ALL	✓	✓	✓	✓	✓	✓	✓	✓	✓	✓	✓	✓	✓	✓	✓



SPECIAL ORDER BLINDS AVAILABLE.
GET IN TOUCH FOR MORE INFORMATION.



FLAT ROOF WINDOWS TYPE Z

- The type Z windows are built based on the design of the type G windows
- A specially constructed glass segment with a slope on the outer surface allows drainage of water
- The type Z flat roof window is suitable for roof pitches 0-15°
- Window design allows for the installation of internal and external accessories

GLAZING EXPLAINED

P2 - Double glazed, toughened outer pane

SIZES AVAILABLE

windows external dimensions [cm]	60x60	60x90	70x70	80x80	90x90	90x120	100x100	120x120
effective glazing area [m ²]	0,23	0,37	0,33	0,46	0,6	0,83	0,77	1,16
size symbol	01K	02K	03K	04K	05K	06K	07K	08K
ALL	✓	✓	✓	✓	✓	✓	✓	✓



SPECIAL ORDER BLINDS AVAILABLE.
GET IN TOUCH FOR MORE INFORMATION.

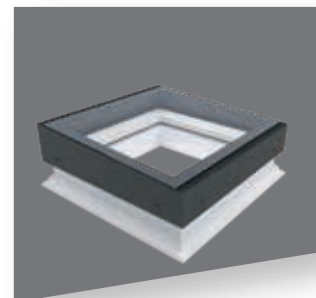

D_Z-A AMZ/Z

- The D_Z-A AMZ/Z version with factory fitted AMZ/Z-Wave awning blind in 308 colour
- High quality and parameters is characterised by high aesthetics of the glass segment performance.
- The profiles have a rounded finish and have an invisible welded connection.
- Available in versions:
 - DEZA – Electrically operated with wireless Z-Wave system, no remote included.
 - DMZ-A – Manually operated
 - DXZA – Non-opening.

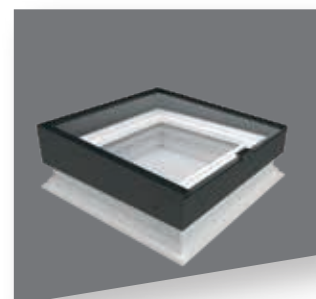

D_Z-B AMZ/Z

- The D_Z-B AMZ/Z version with factory fitted AMZ/Z-Wave awning blind in 308 colour
- The type D_Z-B is an economical version of type A for tighter build budgets compared to type A
- The external profiles are straight finished and are jointed with rivets
- The Glazing is mechanically fastened (with the bottom edge of the glass sheet free)
- Available in versions:
 - DEZ-B – Electrically operated with wireless Z-Wave system, no remote included
 - DMZ-B – Manually operated
 - DXZ-B – Non-opening.

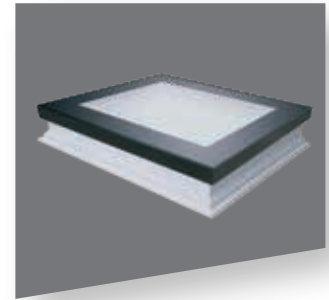

DXW

- Non-opening.
- Enhanced load capacity
- High resistance to break-in attempts thanks to reinforced design.

WALK ON FLAT ROOF WINDOWS

- The frame of the flat roof window is constructed of multi-chamber UPVC profiles filled with insulation material. The upper part of the window comes with an innovative flat glazing unit.
- The window comes with passive, double-chamber glazing unit with a U-value of 0.50 W/m²K.
- Reduced heat loss (U_w=0.70 W/m²K).

GLAZING EXPLAINED

DW6 - Triple glazed, walk-on

SIZES AVAILABLE										
windows external dimensions [cm]	60x60	60x90	70x70	80x80	90x60	90x90	90x120	100x100	120x90	120x120
effective glazing area [m ²]	0,23	0,37	0,33	0,46	0,37	0,6	0,83	0,77	0,83	1,16
size symbol	01K	02K	03K	04K	31K	05K	06K	07K	32K	08K
ALL	✓	✓	✓	✓	✓	✓	✓	✓	✓	✓



SPECIAL ORDER BLINDS AVAILABLE.
GET IN TOUCH FOR MORE INFORMATION.



**PROVIDES LARGE
AMOUNT OF LIGHT**

FLAT ROOF WINDOWS TYPE C



- The type C flat roof window with a dome made of durable polycarbonate



- Can be mounted on an additional base with a height of 15cm



- Suitable for roof pitches between 0 and 15 degrees



- Accessories available

GLAZING EXPLAINED



- P2 - Double glazed**, toughened outer pane



- U8 - Quadruple glazed**, highly energy-efficient

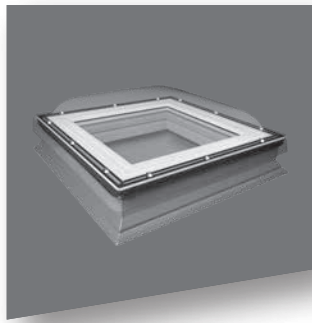

DXC

- Non-opening

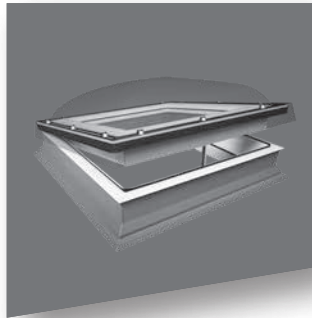

DMC

- Opened manually by means of ZSD control rod 2.2m long included
- Sash tilts 30cm

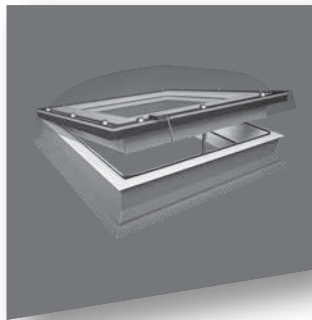

DEC

- Electrically opened with wireless Z-Wave system
- Included in the kit: AC adaptor, rain sensor
- Sash tilts 15cm

POPULAR ACCESSORIES

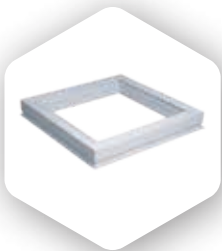

XRD

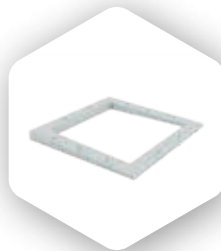

XRD/A

SIZES AVAILABLE

windows external dimensions [cm]	60x60	60x90	70x70	80x80	90x60	90x90	90x120	100x100	100x150	120x90	120x120	120x220	140x140	150x100	200x100
effective glazing area [m ²]	0,23	0,37	0,33	0,46	0,37	0,6	0,83	0,77	1,21	0,83	1,16	2,23	1,63	1,21	1,64
size symbol	01K	02K	03K	04K	31K	05K	06K	07K	10K	32K	08K	11K	09K	33K	34K
DOUBLE GLAZED	✓	✓	✓	✓	✓	✓	✓	✓	✓	✓	✓	✓	✓	✓	✓
QUADRUPLE GLAZED	✓	✓	✓	✓	✓	✓	✓	✓	✓	✓	✓	-	-	✓	✓



SPECIAL ORDER BLINDS AVAILABLE.
GET IN TOUCH FOR MORE INFORMATION.

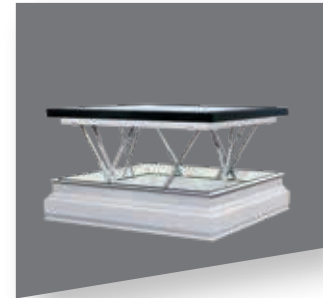

DSF

- Smoke ventilation flat roof window

SMOKE VENTILATION FLAT ROOF WINDOWS

- DSF, DSC smoke ventilation flat roof windows are used for extraction of smoke and heat emitted in a building during a fire. This is a perfect solution for stairwells where under normal operating conditions this window serves the purpose of room ventilation and lighting
- FAKRO smoke ventilation windows combine the standard function of a roof window with that of automatic smoke evacuation in a single product
- Suitable for roof pitches between 0° and 15°. When installing, windows must be level

GLAZING EXPLAINED

- U6 - Triple glazed**, highly energy-efficient
- P2 - Double glazed**, toughened outer pane

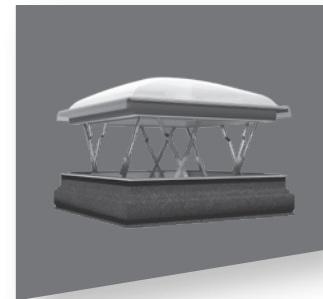

DSC

- Smoke ventilation flat roof window with a dome made of durable polycarbonate. The window is offered in two versions:
 - DSC-C2 P2 with 2 actuators to raise the sash
 - DSC-C4 P2 with 4 actuators to raise the sash

SIZES AVAILABLE

	100x100	105x105	120x120
windows external dimensions [cm]			
effective glazing area [m ²]	0,90	1,0	1,32
size symbol	07K	12K	08K
DSF U6	-	✓	✓
DSC P2	✓	-	✓



FLAT ROOF ACCESS

- Provide safe and convenient access to the flat roof
- Special hinges and functional opening system used in the access roof light ensure easy sash opening up to 80°
- Application of anti-slip covers on profiles window allows its installation, e.g. in green or living roofs
- Gas springs facilitate operation of the sash and keep it stable in the open position, thus protecting against accidental closing

GLAZING EXPLAINED

- U6** - Triple glazed, highly energy-efficient
- P2** - Double glazed, toughened outer pane

SIZES AVAILABLE				
windows external dimensions [cm]	90x90	90x120	100x100	120x120
effective glazing area [m ²]	0,6	0,83	0,77	1,16
size symbol	05K	06K	07K	08K
ALL	✓	✓	✓	✓

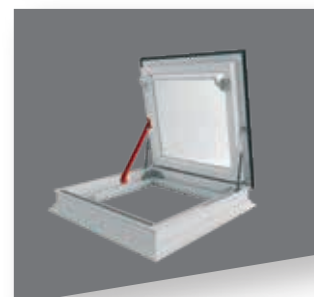

DRF

- Flat access roof light without a dome
- DRF goes with ZBR lock
- The type F flat access roof light is suitable for roof pitches between 2° and 15°

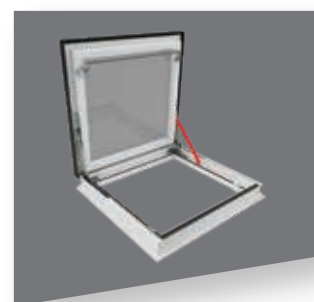

DRG

- Flat access roof light without a dome
- DRG goes with ZBR lock and is compatible with ZBL/D, XRD/W
- Is suitable for roof pitches between 2° and 15°

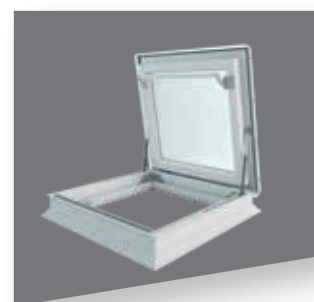

DRC

- Flat access roof light with a dome. The dome can be transparent (DRC-C) or opaque (DEC-M).
- The type C flat access roof light is suitable for roof pitches between 0° and 15°.

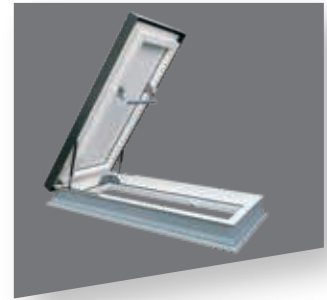

DRL

- Sizes of the roof access door are adjusted according to the size of LML loft ladder (loft ladders are sold separately - see Loft Ladder Catalogue).

FLAT ROOF ACCESS DOOR

- The XRD installation base is designed for flat roof windows type C, G, F and type Z.. It allows you to raise the window above the flat roof by an additional 15cm
- Reduces the time it takes to install a window on a flat roof with an upstand which can raise a window up if required (e.g. green or gravel roofs)
- The profile of the XRD installation base is made of recycled material (grey colour) and is eco-friendly. The profile is filled with insulation material (polystyrene) to ensure a high standard of insulation



LML

SIZES AVAILABLE						
windows external	60x120	70x120	70x130	70x140	86x130	92x130
DRL	✓	✓	✓	✓	✓	✓

ACCESSORIES

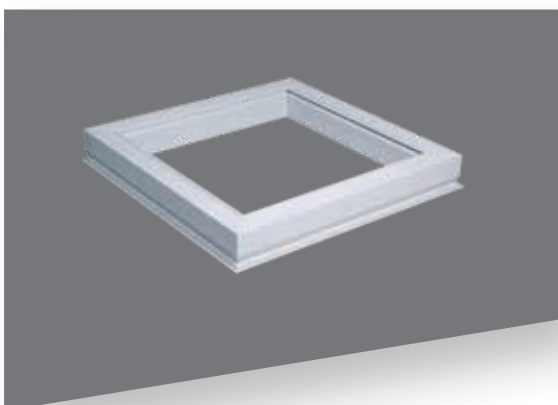

Installation base **XRD**

- The DRL roof access door is an innovative product, providing safe and comfortable access to the flat roof. Its structural durability and range of sizes provide the perfect combination with a loft ladder
- Insulated sash equipped with a rubber seal ensures perfect thermal insulation performance
- The sash can be opened up to 60°. Gas springs facilitate opening and closing and the sash can be left in open position



Awning blind **AMZ/F Solar**

- For type F roof windows
- Comfortable, automatic operation of the blind (intelligent system controls the awning blind depending on the insolation level). Photovoltaic panel acts a sensor and reacts to solar radiation. High insolation levels trigger the awning blind to unroll automatically. In cloudy weather, the awning blind rolls back up automatically without any user intervention
- Powered by a solar battery pack.
Control:
 - Automatic operation or remote control

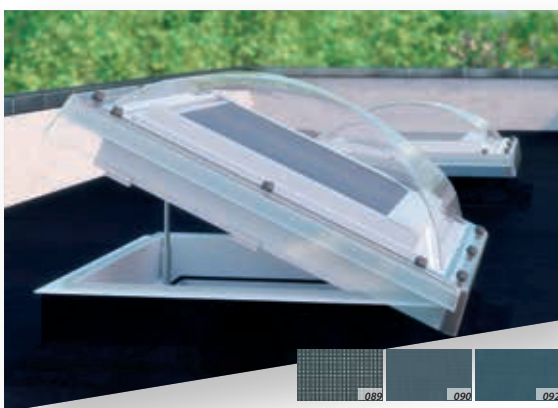

Awning blind **AMZ/CZ-Wave**

- For type C roof windows
- Opened with wireless Z-Wave system
- Innovative profile system enables installation of the awning blind under the window's dome
- Powered from the mains.
Control:
 - Remote control or wall switch



Blackout blinds **ARF/D**

- Very good protection from sunlight
- The possibility of darkening the room
- Possibility to lock the blind in any position
- Partial protection from solar heat



PITCHED ROOF LIGHT TUNNELS

- The light tunnel enables illumination of all rooms in the building, even those which cannot be fitted with roof windows or vertical windows
- Using light tunnels in rooms devoid of daylight lets natural light inside for better illumination. In other rooms, the light tunnel can constitute an additional light source, enhancing the user's comfort and saving energy

SF_ - SIZES AVAILABLE		
light tunnel diameter [cm]	35	55
tube length [cm]	210	210
ALL	✓	✓

light tunnel diameter [cm]	35	55
SLM 30 Flexible light transmitting tube extension kit, standard length 30cm	✓	✓
SLM 60 Flexible light transmitting tube extension kit, standard length 60cm	✓	✓
SLM 90 Flexible light transmitting tube extension kit, standard length 90cm	✓	✓
SLM 120 Flexible light transmitting tube extension kit, standard length 120cm	✓	✓
SLM 210 Flexible light transmitting tube extension kit, standard length 210cm	✓	✓
SLO Light Kit	✓	✓

SR_ - SIZES AVAILABLE		
light tunnel diameter [cm]	35	55
tube length [cm]	210	210
ALL	✓	✓

light tunnel diameter [cm]	35	55
SRM 61 Rigid light transmitting tube extension element, standard length 61cm	✓	✓
SRK Elbow	✓	✓
SLO Light Kit	✓	✓

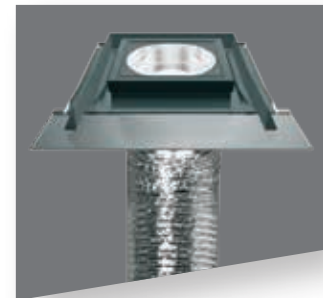

SF_

LIGHT TUNNELS WITH FLEXIBLE TUBE

- Equipped with integrated flashing. Three types of flashings are available: for flat, corrugated and high profile roof coverings.

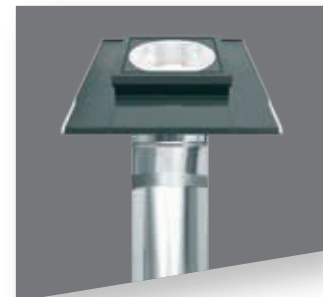

SR_

LIGHT TUNNELS WITH RIGID TUBE

- Equipped with integrated flashing. Three types of flashings are available: for flat, corrugated and high profile roof coverings.

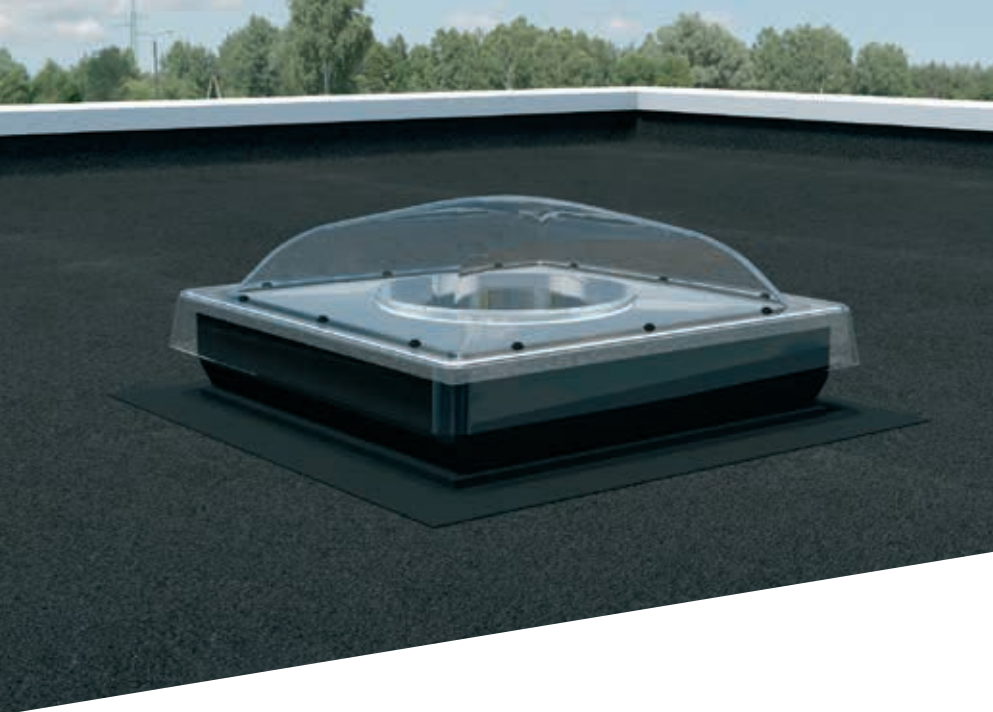

FLAT ROOF LIGHT TUNNELS

- Flat roof light tunnels make it possible to illuminate all rooms under flat roofs with natural light
- A great addition due to its design of the type C flat roof window with a dome that ensures high durability and tightness
- Base of the light tunnel is filled inside with insulation material to secure excellent thermal insulation performance
- Installation of light tunnels allows daylight to rooms under flat roofs

SIZES AVAILABLE

light tunnel diameter [cm]	35	55
tube length [cm]	210	210

SFF	✓	✓
SRF	✓	✓



SPECIAL ACCESSORIES AVAILABLE.
GET IN TOUCH FOR MORE INFORMATION.

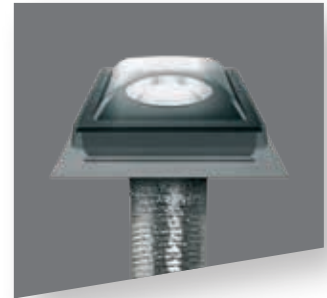

SFF

LIGHT TUNNELS WITH FLEXIBLE TUBE

- A skylight with a flexible light-transmitting tube that allows you to bypass potential structural obstacles. The length of the tube is 210 cm.

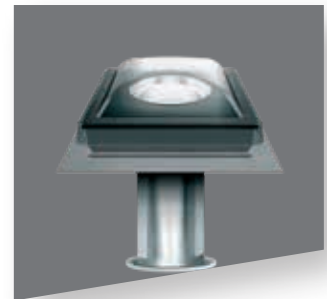

SRF





LIGHT TUNNELS WITH RIGID TUBE

- The light tunnel with the rigid light transmitting tube with a length of 61cm.
- The tube can be extended using a special SRM extension kit.

ROOF WINDOW PERFORMANCE AT A GLANCE

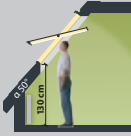
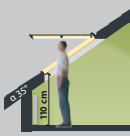
Centre pivot roof windows are still the most popular design, with a wide variety of options including highly energy-efficient windows suited to airtight construction, burglar-resistant windows (particularly suited to low pitch roofs and multi-occupancy buildings). All can be rotated through 180° to clean the outer pane from within the room. A choice of natural pine, white acrylic, white PU-coated pine and UPVC is available.

STANDARD ROOF WINDOWS

type	CENTRE PIVOT								TOP HUNG AND PIVOT WINDOWS			
												
material	wood		PVC		wood		wood		wood		PVC	
natural pine	FTP-V P2	FTP-V P5	—	—	FTP-V P2 Z-wave, Solar, WiFi	FTP-V P5 Z-wave, Solar, WiFi	FTT U8 Thermo	FTT U6	FPP-V P2 preSelectMAX	FPP-V P5 preSelectMAX	-	-
white acrylic	FTW-V P2	FTW-V P5	—	—	FTW-V P2 Z-wave, Solar, WiFi	FTW-V P5 Z-wave, Solar, WiFi	FTT/W U8 Thermo	FTT/W U6	FPW-V P2 preSelectMAX	FPW-V P5 preSelectMAX	-	-
white polyurethane	FTU-V P2	FTU-V P5	—	—	FTU-V P2 Z-wave, Solar, WiFi	FTU-V P5 Z-wave, Solar, WiFi	FTT/U U8 Thermo	FTT/U U6	FPU-V P2 preSelectMAX	FPU-V P5 preSelectMAX	-	-
UPVC	—	—	PTP-V P2	PTP-V P5	—	—	—	—	—	—	PPP-V P2 preSelectMAX	PPP-V P5 preSelectMAX
conservation version:	+	+	+	+	+	+	+	+	+	+	+	+
air inlet			V35				non-vented				V35	
air inlet air flow	up to 49 m³/h		up to 41 m³/h		up to 49 m³/h		-		up to 49 m³/h		up to 41 m³/h	
glazing	double	triple	double	triple	double	triple	quadruple	triple	double	triple	double	triple
Ug (EN 673)	1,0 W/m²K	0,5 W/m²K	1,0 W/m²K	0,5 W/m²K	1,0 W/m²K	0,5 W/m²K	0,3 W/m²K	0,5 W/m²K	1,0 W/m²K	0,5 W/m²K	1,0 W/m²K	0,5 W/m²K
Uw	1,3 W/m²K	0,97 W/m²K	1,3 W/m²K	1,0 W/m²K	1,3 W/m²K	0,97 W/m²K	0,58 W/m²K	0,80 W/m²K	1,3 W/m²K	0,97 W/m²K	1,3 W/m²K	1,0 W/m²K
topSafe system	+		+		+		+		+		+	
acoustic insulation	35 dB	35 dB	33 dB	36 dB	35 dB	35 dB	36 dB	38 dB	35 dB	35 dB	33 dB	36 dB
handle	elegant		elegant white		elegant		elegant		elegant		elegant white	
seals	4		4		4		5		4		4	
installation pitch	15-90°		15-90°		15-90°		15-70°		15-55°		15-55°	

GLAZING UNIT

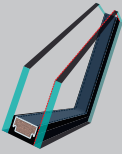
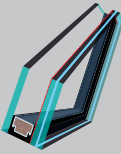
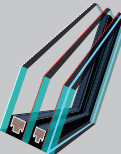
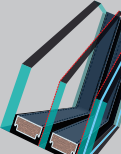
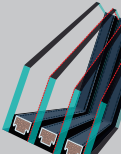
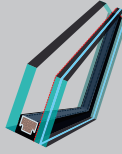
						
GLAZING UNIT	U3	P2	P5	U6	U8	R1
GLAZING STRUCTURE	4H-16-4T	4H-15-33.2T	4HS-10-4HT-8-33.2T	6H-18-4HT-18-33.2T	4H-12-4HT-12-4HT-12-4HT	6H-12-33.2SIT
TECHNICAL SPECIFICATION	ENERGY SAVING	ANTI BURGLARY	SAFE	HIGHLY ENERGY EFFICIENT	PASSIVE GLAZING	SOUND REDUCING
GLAZING	DOUBLE	DOUBLE	TRIPLE	TRIPLE	QUADRUPLE	DOUBLE
INNER LAMINATED GLASS		(CLASS P2A)	(CLASS P2A)	(CLASS P2A)		(CLASS P2A)

Top hung and pivot dual function roof windows provides total flexibility of use. When open, the top hung function provides an unrestricted field of view at a lower height than a centre pivot window while centre pivot operation enables the sash to be rotated through 180° to clean the outer pane from within the room. A choice of natural pine, white PU-coated pine and UPVC is available.

High pivot roof windows function in the same way as a centre pivot window but with the axis of rotation slightly higher in the frame to enable even taller people to walk up to the open window. This enables a greater glazing height to be achieved without adding to the window's width. With scope also to choose a twin sash window in a single frame (the FDY-V proSky Duet window), this can extend up to 2.35 metres.

The Balcony window is the ultimate, modern twin sash window. With the top sash opening as a top hung window, the bottom sash with laminated internal glazing opens from the bottom to reveal built-in balustrades.

L-shaped windows provide scope to take any of FAKRO's standard roof windows into a vertical wall. This gives a much extended field of view and a bigger glazing area which maximises the use of natural daylight.

HIGH PIVOT		BALCONY		L-SHAPED		SMOKE VENTILATION WINDOW		SIDE HUNG					
wood		wood		wood		wood		wood		PVC			
FYP-V P2 proSky	FYP-V P5 proSky	FDY-V P2 Duet proSky		FGH-V P2 Galeria	FGH-V P5 Galeria	BD_P2, BVP P2, BX P2	BD_P5, BVP P5, BX P5	FSR P2	FSR P5	FWP P2	FWP P5	—	—
FYW-V P2 proSky	FYW-V P5 proSky			FGH-V/W P2 Galeria	FGH-V/W P5 Galeria	BD_AV P2, BVW P2, BXW P2	BD_AV P5, BVW P5, BXW P5	FSR/W P2	FSR/W P5	FWW P2	FWW P5	—	—
FYU-V P2 proSky	FYU-V P5 proSky	FDY-V/U P2 Duet proSky		FGH-V/U P2 Galeria	FGH-V/U P5 Galeria	BD_U P2, BVU P2, BXU P2	BD_U P5, BVU P5, BXU P5	FSR/U P2	FSR/U P5	FWU P2	FWU P5	—	—
—	—	—		—	—	+	+	—	—	—	—	PWP P2	PWP P5
+	+	+		—	—	—	—	—	—	+	+	+	+
						—		—		—		—	
up to 49 m³/h		up to 49 m³/h		up to 49 m³/h		—		—		—		—	
double	triple	double		double	triple	double	triple	double	triple	double	triple	double	triple
1,0 W/m²K	0,5 W/m²K	1,0 W/m²K		1,1 W/m²K	0,5 W/m²K	1,1 W/m²K	0,5 W/m²K	1,1 W/m²K	0,5 W/m²K	1,0 W/m²K	0,5 W/m²K	1,0 W/m²K	0,5 W/m²K
1,3 W/m²K	0,97 W/m²K	1,3 W/m²K		1,5 W/m²K	1,1 W/m²K	1,3 W/m²K	0,88 W/m²K	—	—	1,3 W/m²K	1,1 W/m²K	1,3 W/m²K	1,1 W/m²K
+		+		+		—		—		—		—	
35 dB	33 dB	35 dB		35 dB	34 dB	37 dB	38 dB	—	—	35 dB			
elegant		elegant		elegant		elegant		—		standard		standard	
4		4		4		2		2		4		4	
20-65°		25-65°		35-55°	40-55°	90°		15-90°		15-55°		15-55°	

FLAT ROOF WINDOW PERFORMANCE AT A GLANCE

Flat roof windows - The special structure of FAKRO flat roof windows provides excellent thermal insulation. The FAKRO product range includes flat roof windows with or without domes (type **F**, type **G**, type **Z** and type **C**) and walkable window **DXW**.

Smoke and heat exhaust ventilation flat roof windows DSF, DSC smoke ventilation flat roof windows are used for extraction of smoke and heat emitted in a building during a fire.

Flat roof access windows: Insulated **DRF, DRC** access roof lights are yet another one of FAKRO's innovative products. The range is expanding and creating solutions which provide safe and convenient access to the roof.

STANDARD FLAT ROOF WINDOWS

FLAT ROOF WINDOWS									
DXF	DMF	DEF***	DXG	DMG	DEG***	DXZ AMZ/Z	DMZ AMZ/Z	DEZ AMZ/Z***	DXW
<ul style="list-style-type: none"> Type F flat roof window. Suitable for pitches from 2-15°. The frame constructed of multi-chamber PVC profiles filled with insulation material. Can be mounted on an additional XRD base with a height of 15cm. 			<ul style="list-style-type: none"> Suitable for pitches from 2-15°**. Covered with a special glass section which consists of toughened glass featuring a thickness of 4mm or 6mm. Window is factory equipped with glass section. Specially prepared aluminium black profile. The frame constructed of multi-chamber PVC profiles filled with insulation material. Can be mounted on an additional XRD base with a height of 15cm. 			<ul style="list-style-type: none"> Suitable for pitches from 0-15°. A new line of the D_Z windows offer the widest range of applications, complementing the FAKRO flat roof window range. The new line comes in two versions: <ul style="list-style-type: none"> D_Z-A, high quality and very good parameters combined with modern aesthetics, D_Z-B, high thermal insulation performance with the product. All D_Z windows are factory fitted AMZ/Z-Wave awning blind in 308 colour. 			<ul style="list-style-type: none"> Suitable for pitches from 0-15°. Can be installed completely flush within the roofline. Special design ensures safe walk across the window surface.

GLAZING UNIT







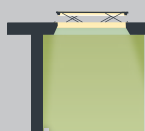
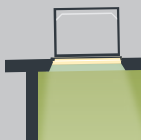

GLAZING UNIT	P2	U8(VSG)	DU6	DU8	DW6
GLAZING STRUCTURE	4-14-33.2	4-10-4-12-4-12-33.2	6-18-4-18-44.2 / 6-16-4-18-55.2*	6-10-4-10-4-12-44.2	888.44-16-4-18-66.2
TECHNICAL SPECIFICATION	ANTI BURGLARY	PASSIVE GLAZING	HIGHLY ENERGY EFFICIENT	PASSIVE GLAZING	WALKABLE
GLAZING	DOUBLE	QUADRUPLE	TRIPLE	QUADRUPLE	TRIPLE
INNER LAMINATED GLASS	(CLASS P2A)	(CLASS P2A)	(CLASS P2A)	(CLASS P2A)	(CLASS P2A)

* THE STRUCTURE OF THE GLAZING UNIT FOR SIZE 120x120 AND LARGER

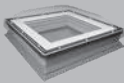
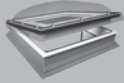
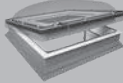
**MINIMUM ROOF PITCH OF 5 DEGREES ON THE G-RANGE IN SIZES 140X140 AND 120X 220 SUITS A ROOF PITCH OF 5-15

***DOES NOT INCLUDE REMOTE CONTROL

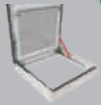
Escape - the **DRL** roof access door is an innovative product providing safe and comfortable access to the flat roof. Its structural durability and range of sizes provide the perfect combination with a loft ladder.

			SMOKE AND HEAT EXHAUST VENTILATION FLAT ROOF WINDOWS		FLAT ROOF ACCESS WINDOWS			ESCAPE
								
DXC	DMC	DEC***	DSF	DSC	DRF	DRC	DRG	DRL
								
<ul style="list-style-type: none"> • Suitable for pitches from 0-15°. • Dome made of durable polycarbonate in a transparent or an opaque version. • Can be mounted on an additional XRD base with a height of 15cm. 			<ul style="list-style-type: none"> • Suitable for roof pitches between 0° and 15°. When installing, windows must be level. • The frame constructed of multi-chamber PVC profiles filled with insulation material. • The sash raises easily to a height of 23cm when used for everyday ventilation. • In the event of fire the sash raises to 50cm. 		<ul style="list-style-type: none"> • Suitable for pitches from 2-15°. • Suitable for pitches from 0-15°. • Suitable for pitches from 2-15°. 			<ul style="list-style-type: none"> • Suitable for pitches from 0-5°. • Designed to be installed together with FAKRO loft ladders LML type (comprehensive solution providing convenient access to the flat roof). • Easy and convenient operation thanks to gas springs. • Sash opened to 60°.
					<ul style="list-style-type: none"> • Easy and convenient operation thanks to gas springs. • Sash opened to 80° (90x120 and 120x120 opened to 60°) • Can be mounted on an additional XRD/W base with a height of 15cm (e.g. for installation in green roofs). 			

NEW





LOFT LADDERS

FOLDING LOFT LADDERS enable safe and easy access to loft spaces without the need for costly and space-consuming staircases. FAKRO ladders satisfy all technical and safety requirements whilst maximising ease of use and comfort.

FAKRO offers a choice of wood and metal loft ladders to satisfy the needs of each individual customer and home. All FAKRO folding ladders offer a high degree of thermal efficiency.

All loft ladders compliant with EN 14975.

NEW



LOFT LADDER TYPE	LWK Komfort	LTK Energy	LWF 60	LMF 120	LST
	 U=1.1 W/m ² K	 U=0.68 W/m ² K	 EN13501-2 EI₁ 60 U=0.64 W/m ² K	 EN13501-2 EI₁ 120 U=0.79 W/m ² K	 U=1.1 W/m ² K
Room height [cm]		280, 305		280, 305	250-280
Box		pinewood		metal	pinewood
Hatch	thermo-insulating	extra thermo-insulating	fire-resistant	fire-resistant	thermo-insulating
Hatch colour	white	white	white	white	white
Ladder		pinewood		metal	metal
Treads		non-slip treads set flush with ladder strings		metal, anti-slip	metal, anti-slip
Thermal insulation thickness	3 cm	6 cm	7.9 cm	8cm	3 cm
Hatch thickness	3.6 cm	6.6 cm	8.5 cm	8.2 cm	3.6 cm
Maximum loading	160 kg	160 kg	160 kg	200 kg	200 kg

*MANUFACTURER'S INTERNAL RESEARCH.



L-SHAPED COMBINATION DOORS

In addition to having a wide range of loft ladders FAKRO also manufacture combination loft doors for installation in walls. These are used to provide access to unused space behind a wall or under stairs. Three models are available, the first and most basic model, the **DWK** insulating door having a 3.6cm thick sash. For added thermal efficiency and airtightness the **DWT** provides a U-value of 0.6 and offers Class 4: EN 12207 performance. Where fire resistance is required, the **DWF** offers double-sided protection (fire classification EI₁45 EN 13501-2), as well as exceptional airtightness and thermal insulation.

DOOR TYPE	DWK	DWT	DWF
	 U=1.1 W/m ² K	 U=0.6 W/m ² K 4 CLASS EN12207	 U=0.64 W/m ² K 4 CLASS EN12207 EN13501-2 EI₁ 45
	INSULATED	HIGHLY ENERGY EFFICIENT	FIRE-RESISTANT
Sash structure	Frame made of pinewood clad on both sides with HDF board and filled inside with insulation material		
Sash colour	white		
Opening	right or left side		
Closing	universal handle with a lock		
Finishing trims	3.5 cm wide wooden in a natural colour		
Thermal insulation thickness	3 cm	6 cm	
Sash thickness	3.6 cm	6.6 cm	



WINDOW SIZE GUIDE

Simply check the height and width dimensions for your chosen window, and see the choice of products available based on the P2 glazing unit.

HEIGHT in cm	WIDTH in cm					
	55	66	78	94	114	134
60			FNP *	FNP *	FNP *	FNP *
78	FTP-V PTP	FWR FWL FTP-V PTP-V PTP	FNP/D* FTP-V PTP-V PTP	FNP/D* FTP-V PTP-V PTP	FNP/D* FTP-V PTP-V PTP	FNP/D* FTP-V PTP-V PTP
98	FTP-V FPP-V PTP PPP-V	FTP-V FPP-V PTP PPP-V FWR FWL	FTP-V FPP-V PTP PPP-V FWR FWL	FWL	FTP-V PTP-V PTP	FTP-V FPP-V
118	FTP-V FPP-V PTP PPP-V	FTP-V FPP-V PTP PPP-V FWR FWL	FTP-V FPP-V PTP PPP-V FWR FWL	FTP-V FPP-V PTP PPP-V FWR FWL	FTP-V PTP-V PTP ESP FWR FWL	FTP-V PTP-V PTP
140	FTP-V FPP-V PTP PPP-V	FTP-V FPP-V PTP PPP-V	FTP-V FPP-V PTP PPP-V FYP-V FHP FWR FWL	FTP-V FPP-V PTP PPP-V FYP-V FHP FWR FWL	FTP-V FPP-V PPP-V FSP	
160			FYP-V FTP-V PTP-V PTP FPP-V	FYP-V FTP-V PTP-V** PTP**		
180			FYP-V	FYP-V		
186			FDY-V	FDY-V		
206			FDY-V FYP-V	FDY-V FYP-V		
235			FDY-V ***	FDY-V ***		
255			FDY-V ***	FDY-V *** FGH-V P2		

HEIGHT in cm	WIDTH in cm			WIDTH in cm	
	78	94	114	46	54
60	BDL BDR BXP	BXP	BXP	WGT	
75	BDL BDR BXP	BDL BDR BXP		WGT/C	
95	BDL BDR	BDL BDR	BDL BDR	WGT WGI	
98				WLI/C	

Flat Roof Windows

HEIGHT in cm	WIDTH in cm					
	55	66	78	94	114	134
78	EFW					
98	EFW	EFW	EFW			EFW
118		EFW	EFW	EFW	EFW	
140			EFW	EFW	EFW	

FAKRO Light Tunnels

FAKRO Light Tunnels are available with either flexible or rigid ducting. Either product may also be purchased with an abutment accessory for fitting on flat roofs.

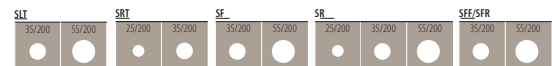

Conservation Roof Windows

FAKRO supplies the widest range of products and sizes in conservation style. See each section in the price list for full details.



NOTE: THE SIZES NOT STATED IN THE PRICE LIST AVAILABLE TO INDIVIDUAL ORDERS. PRICES ON REQUEST.

- * NON-OPENING WINDOWS. PRICES ON REQUEST
- ** PTP-V P2, PTP P2 RECOMMENDED FOR THE ROOFS WITH PITCH FROM 25 DEGREE
- *** AVAILABLE TO INDIVIDUAL ORDERS. PRICES ON REQUEST

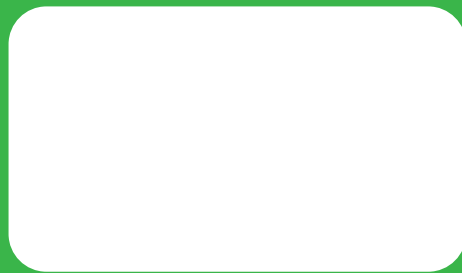

 **FAKRO**[®]

Fakro GB Ltd
Fakro House
Astron Business Park
Hearthcote Road
Swadlincote DE11 9DW
telephone : 01283 554755 fax : 01283 224545
www.fakro.co.uk e-mail: sales@fakrogb.com

FAKRO RESERVES THE RIGHT TO CHANGE SPECIFICATIONS AND TECHNICAL PARAMETERS OF PRODUCTS WITHOUT PRIOR NOTICE.